

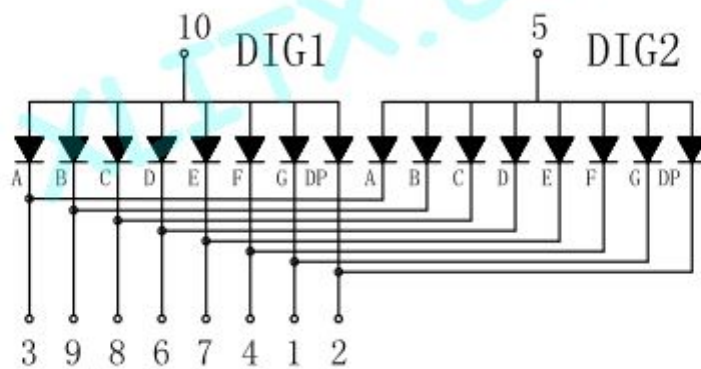

| | |
|-------------------------|-----------------------|
| Model : | CL3621BH |
| Size : | 0.36-inch |
| Emitting color : | Red (Ultra-Bright) |
| Mode : | Common-Anode (CA) |
| Digit : | 2-Digit |
| Category : | LED 7-Segment Display |
| Maker : | XLITX Technology |

Prices : \$0.66 = 100 Pieces \$0.31 = 500 Pieces \$0.26 = 1000 Pieces (Free shipping)

Dimension & Diagram

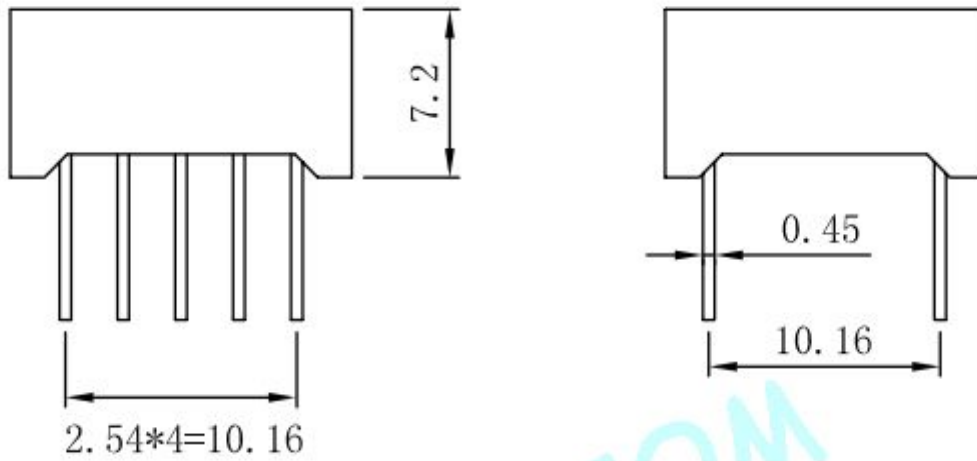
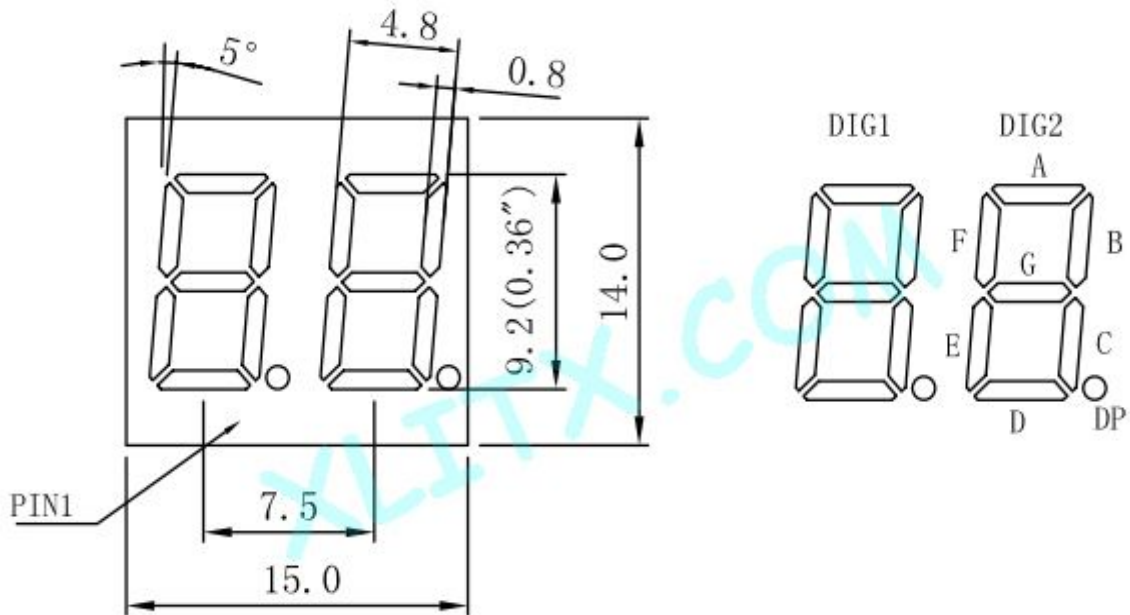

Ultra-Bright Red Electro-Optical Parameter

1. Electro-Optical Characteristics(Ta=25°C)

| PARAMETER | SYMBOL | DEVICES (ULTRA-BRIGHT RED) | | UNIT | TEST CONDIONS |
|---|-------------|---------------------------------|-----|---------|---------------|
| | | TYP | MAX | | |
| Peak Emission Wavelengrth | λ_p | 640 | | nm | IF=10mA |
| Forward Voltage | VF | 1.8 | | V | IF=10mA |
| Reverse Current | IR | | 50 | μ A | VR=5V |
| Segment To Segment (Dot To Dot) Luminonous Intensity Ratio | IV-M | 1.5:1 | | | IF=20 |

2. Absolute Maximun Ratings(Ta=25°C)

| PARAMETER | SYMBOL | DEVICES (ULTRA-BRIGHT RED) | UNIT |
|--|--------|--|-------|
| Power Dissipation Per Dice | pad | 100 | mw |
| Derating Linear From 25°C Per Dice | | 0.5 | mA/°C |
| Continuous Forward Current Per Dice | laf | 30 | mA |
| Peak Forward Ourrent Per Dice (Duty Cycle 1/10,10KHz) | lpf | 200 | mA |
| Reverse Voltage Per Dice | Vr | 5 | V |
| Operating Temperature | Topr | -20°C (to) +75°C | |
| Storage Temperature | Tstg | -20°C (to) +85°C | |
| Solder Temperature | | 1.6 Inch Below Seating Place for 5 seconds at 230°C | |

3. Electro-Optical Curve

相对亮度与波长 RELATIVE INTENSITY VS WAVELENGTH



顺电流-顺电压特性
FORWARD CURRENT VS FORWARD VOLTAGE



相对光度-顺电流特性
LUMINOUS INTENSITY VS FORWARD CURRENT



允许顺电流-周围温度特性



相对光度-周围温度特性
LUMINOUS INTENSITY VS AMBIENT TEMPERATURE

