

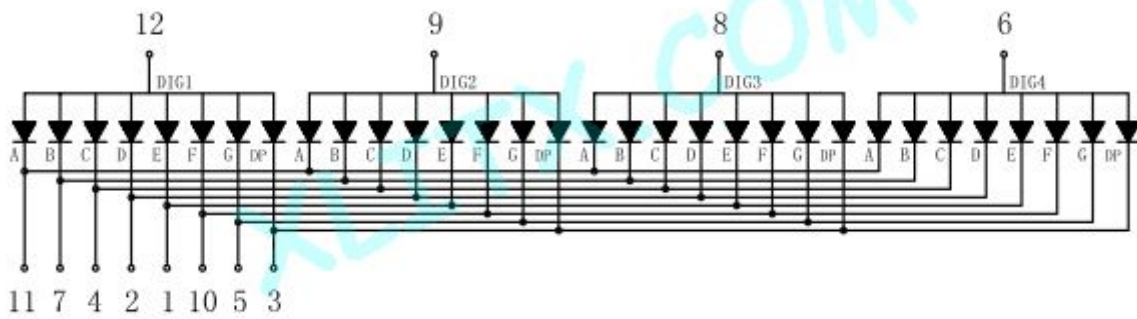

**Model :** 3641BGG  
**Size :** 0.36-inch  
**Emitting color :** Green  
**Mode :** Common-Anode (CA)  
**Digit :** 4-Digit  
**Category :** LED 7-Segment Display  
**Maker :** XLITX Technology

**Prices :** \$1.00 = 100 Pieces    \$0.81 = 500 Pieces    \$0.79 = 1000 Pieces    (Free shipping)

Dimension & Diagram

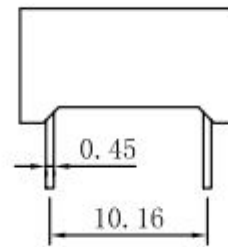
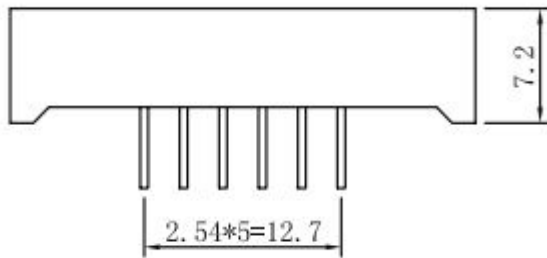
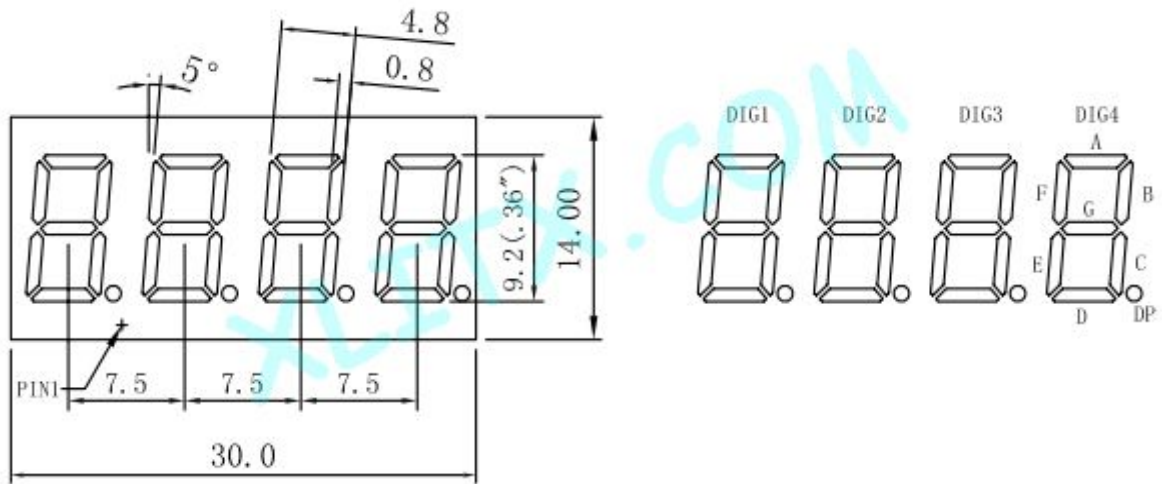

## Green Electro-Optical Parameter

### 1. Electro-Optical Characteristics(Ta=25°C)

PARAMETER	SYMBOL	DEVICES ( Green )		UNIT	TEST CONDIONS
		TYP	MAX		
Peak Emission Wavelengrth	$\lambda_p$	525		nm	IF=10mA
Forward Voltage	VF	3.5		V	IF=10mA
Reverse Current	IR		50	$\mu$ A	VR=5V
Segment To Segment (Dot To Dot) Luminonous Intensity Ratio	IV-M	1.5:1			IF=20

### 2. Absolute Maximun Ratings(Ta=25°C)

PARAMETER	SYMBOL	DEVICES ( Green )	UNIT
Power Dissipation Per Dice	pad	52.5	mw
Derating Linear From 25°C Per Dice		0.27	mA/°C
Continuous Forward Current Per Dice	laf	25	mA
Peak Forward Ourrent Per Dice (Duty Cycle 1/10,10KHz)	lpf	80	mA
Reverse Voltage Per Dice	Vr	5	V
Operating Temperature	Topr	-20°C (to) +75°C	
Storage Temperature	Tstg	-20°C (to) +85°C	
Solder Temperature		1.6 Inch Below Seating Place for 5 seconds at 230°C	

3. Electro-Optical Curve

相对高度与波长 RELATIVE INTENSITY VS WAVELENGTH

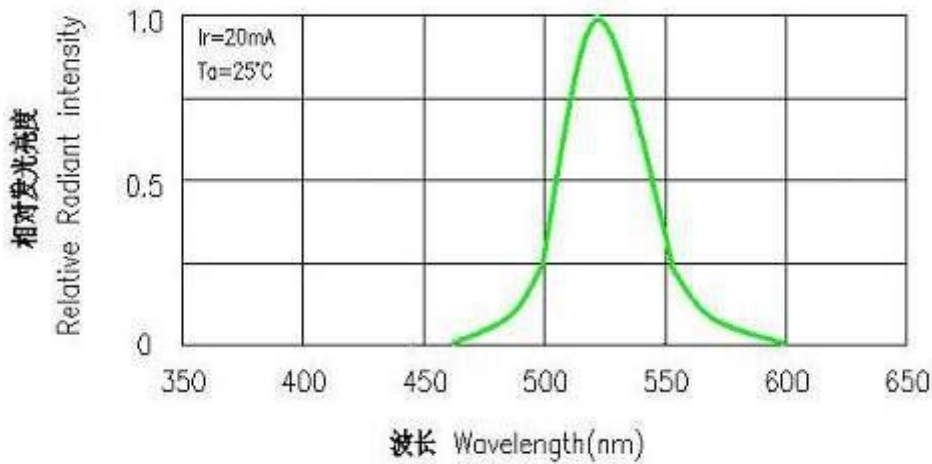

顺电流-顺电压特性  
FORWARD CURRENT VS FORWARD VOLTAGE

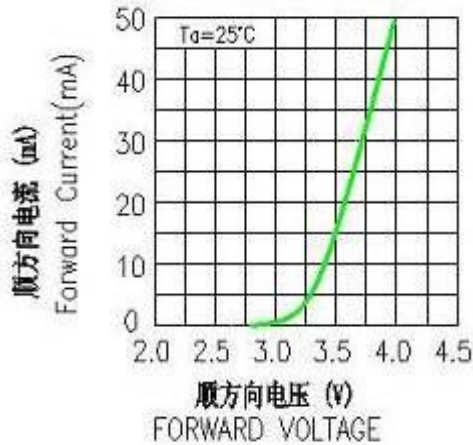

相对光度-顺电流特性  
LUMINOUS INTENSITY VS FORWARD CURRENT

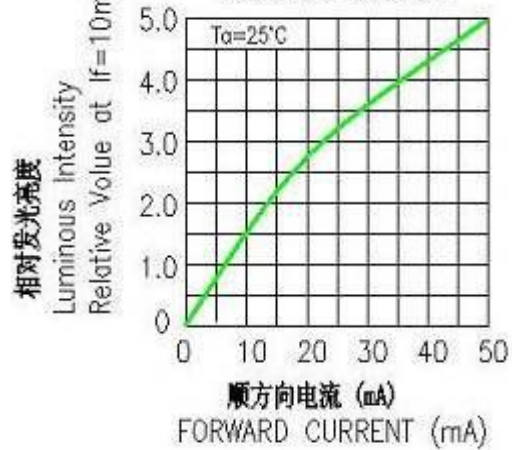

允许顺电流-周围温度特性  
ALLOWABLE FORWARD CURRENT AMBIENT TEMPERATURE

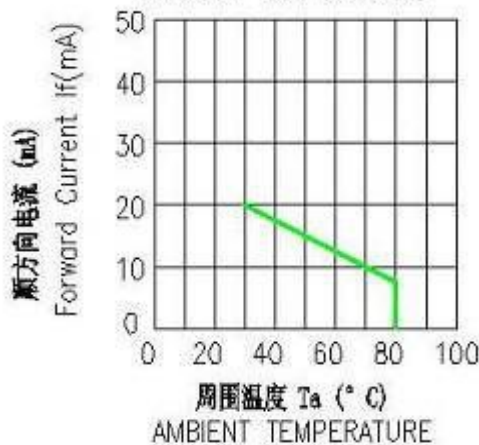

相对光度-周围温度特性  
LUMINOUS INTENSITY VS AMBIENT TEMPERATURE

