

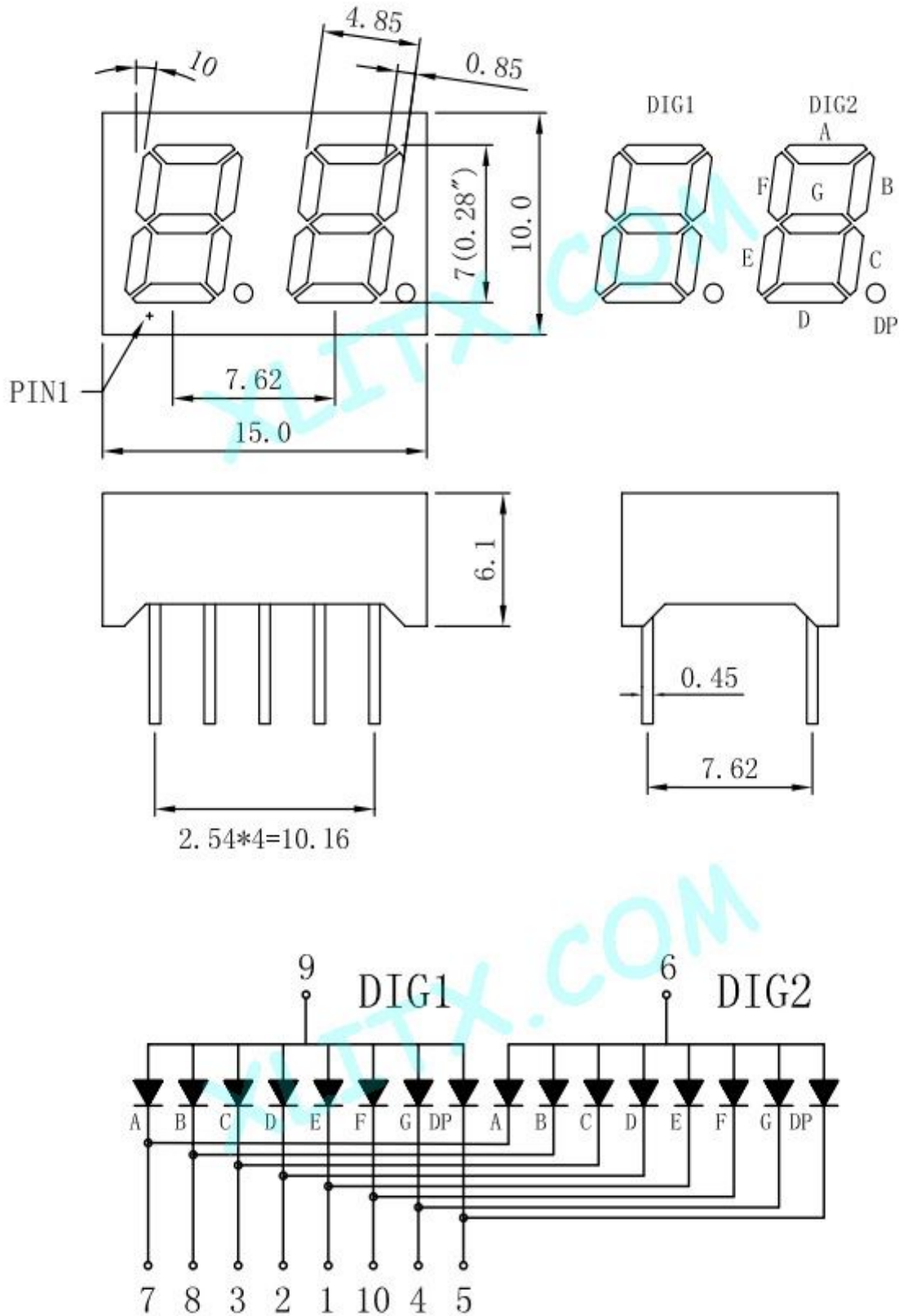

<b>Model :</b>	2821BS
<b>Size :</b>	0.28-inch
<b>Emitting color :</b>	Red (Ultra-Bright )
<b>Mode :</b>	Common-Anode (CA)
<b>Digit :</b>	2-Digit
<b>Category :</b>	LED 7-Segment Display
<b>Maker :</b>	XLITX Technology

**Prices :** \$0.56 = 100 Pieces    \$0.27 = 500 Pieces    \$0.24 = 1000 Pieces    (Free shipping)

Dimension & Diagram



## Ultra-Bright Red Electro-Optical Parameter

### 1. Electro-Optical Characteristics(Ta=25°C)

PARAMETER	SYMBOL	DEVICES ( ULTRA-BRIGHT RED )		UNIT	TEST CONDIONS
		TYP	MAX		
Peak Emission Wavelengrth	$\lambda_p$	640		nm	IF=10mA
Forward Voltage	VF	1.8		V	IF=10mA
Reverse Current	IR		50	$\mu$ A	VR=5V
Segment To Segment (Dot To Dot) Luminonous Intensity Ratio	IV-M	1.5:1			IF=20

### 2. Absolute Maximun Ratings(Ta=25°C)

PARAMETER	SYMBOL	DEVICES ( ULTRA-BRIGHT RED )	UNIT
Power Dissipation Per Dice	pad	100	mw
Derating Linear From 25°C Per Dice		0.5	mA/°C
Continuous Forward Current Per Dice	laf	30	mA
Peak Forward Ourrent Per Dice (Duty Cycle 1/10,10KHz)	lpf	200	mA
Reverse Voltage Per Dice	Vr	5	V
Operating Temperature	Topr	-20°C (to) +75°C	
Storage Temperature	Tstg	-20°C (to) +85°C	
Solder Temperature		1.6 Inch Below Seating Place for 5 seconds at 230°C	

3. Electro-Optical Curve

相对亮度与波长 RELATIVE INTENSITY VS WAVELENGTH



顺电流-顺电压特性  
FORWARD CURRENT VS  
FORWARD VOLTAGE



相对光度-顺电流特性  
LUMINOUS INTENSITY VS  
FORWARD CURRENT



允许顺电流-周围温度特性



相对光度-周围温度特性  
LUMINOUS INTENSITY VS  
AMBIENT TEMPERATURE

